

THECNICAL

Model	Air delivery m ³ /min	Pipe connections	Maximum working pressure	Dimensions mm			Weight kg
				A	B	C	
FM 0005	0,5	3/8"	16	220	90	25	0,6
FM 0010	1	1/2"	16	220	90	25	0,6
FM 0018	2	3/4"	16	280	90	25	0,7
FM 0030	3	3/4"	16	280	90	25	0,7
FM 0035	3,4	1"	16	305	120	37	1,1
FM 0050	5	1"	16	305	120	37	1,2
FM 0072	7,2	1 1/2"	16	385	120	37	1,3
FM 0095	9,5	1 1/2"	16	385	120	37	1,4
FM 0125	12,5	2"	15	500	165	54	3,7
FM 0165	17	2"	16	500	165	54	3,8
FM 0190	19	2 1/2"	16	675	165	54	4,8
FM 0220	24	2 1/2"	16	675	165	54	4,9
FM 0280	28	3"	16	710	200	65	6,7
FM 0350	35	3"	16	865	200	65	7,9
FM 0440	44	3"	13	985	200	65	8,8
FM 0360	36	DN 100	12	1030	490	210	95
FM 0450	45	DN 100	12	1060	490	210	95
FM 0600	60	DN 100	12	1060	490	290	130
FM 0900	90	DN 150	12	1180	590	350	150
FM 1200	120	DN 150	12	1200	640	420	230
FM 1500	150	DN 175	12	1410	770	470	240
FM 1800	180	DN 200	12	1440	800	470	350

For models
from FM 0005 to FM 0440

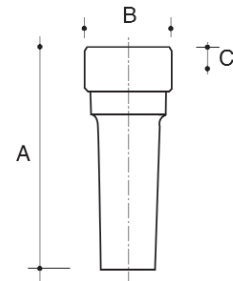

For model
from FM 0360 to FM 1800

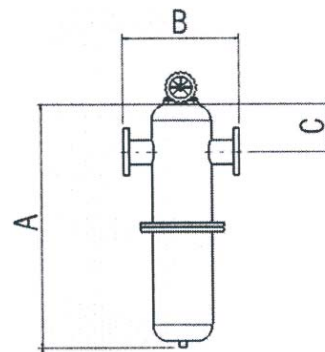

Performances refer to 1bar (a) and to the following operating conditions: intake air at 25°C/60%RH, 7 bar working pressure in bar, 35°C compressed air inlet temperature.

PURITY CLASS AND MODEL

Oil - Class ISO 8573.1		Solids - Class ISO 8573.1		*Example of filter selection: FM 0050 C3 ← Filter grade specification ↑ Filter Model/Size
C4 - purity class	-	C4 - purity class	7	
C3 - purity class	4	C3 - purity class	3	
C2 - purity class	2	C2 - purity class	2	
C1 - purity class	1	C1 - purity class	1	
CC - purity class	N.A.	CC - purity class	N.A.	

FLOW RATE CORRECTION FACTORS

Pressure bar (g)	2	3	4	5	6	7	8	9	10	11	12	13	14	15	16
	0,36	0,50	0,63	0,75	0,88	1,00	1,13	1,25	1,38	1,50	1,63	1,75	1,88	2,00	2,13

Ing. Enea Mattei SpA reserves the right to change the data contained in this catalogue at any moment and without notice.

ITALY

ING. ENEA MATTEI SpA
Strada Padana Superiore, 307
20090 VIMODRONE (MI)
Tel +39 02253051 - Fax +39 0225305243
E-MAIL: info@mattei.it

www.mattei.it

SPAIN

ING. ENEA MATTEI SpA
Phone +34 93 435 03 94 - Fax +34 93 455 26 76
E-MAIL: info@mattei.it

FRANCE

MATTEI COMPRESSEURS Sarl
Phone +33 1 60081212 - Fax +33 1 60085252
E-MAIL: info@mattei.fr

GERMANY

MATTEI KOMPRESSOREN DEUTSCHLAND GmbH
Phone +49 7151 5002560 - Fax +49 7151 5002565
E-MAIL: info@mattei-kompressoren.de

GREAT BRITAIN

MATTEI COMPRESSORS Ltd
Phone +44 (0)1789 450577 - Fax +44 (0)1789 450698
E-MAIL: info@mattei.co.uk

RUSSIAN FEDERATION

ING. ENEA MATTEI SpA
Phone +7-495-739 41 90 Fax +7-495-739 41 90
E-MAIL: mattei@inbox.ru

SINGAPORE Representative Office Asia Pacific

ING. ENEA MATTEI SpA
Phone +65 6741 8187 - Fax. +65 6741 6826
E-MAIL: mattei@singnet.com.sg

U.S.A.

MATTEI COMPRESSORS Inc
Phone +1 410 5217020 - Fax +1 410 5217024
E-MAIL: info@matteicomp.com



FM COMPRESSED AIR FILTERS



COMPANY
WITH QUALITY MANAGEMENT
SYSTEM CERTIFIED BY DNV
=ISO 9001:2000=

PURE AIR

GUARANTEED BY A SUPERIOR PRODUCT

In modern manufacturing processes compressed air plays the role of safe, reliable and economic energy. The air delivered by compressors must be treated to obtain quality air. Otherwise, the life of pneumatic tools and the quality of finished products will be jeopardized. Two different types of contaminants may seriously affect the quality of compressed air:

- 1) atmospheric contaminant;
- 2) plant contaminants.

Regarding atmospheric pollution, a cubic metre of urban compressed air at 7 bar can contain one thousand million particles, including fine dust (combustion particles) gas and hydrocarbon vapour originating from industrial discharges. Contamination of the air system occurs because compressors and fittings can produce rust particles, waste and lubricating oil sludge. Even "oil free" compressors have this problem, as they compress gases, oil vapours and fine particles contained in the polluted atmosphere and then condensating in the air system.

Contaminants produce corrosive emulsions obstructing the pipelines, increasing the load losses (and consequently the manufacturing costs), such emulsions may clog and wear out pneumatic tools and sometimes also the air system is blocked. Mattei, a market leader in compressed air technology, supplies a wide range of high efficiency filters to eliminate impurities and contaminants in all industrial applications of compressed air. Particularly, Mattei filters ensure the air is up to 99,99% technically oil free by the use of specific materials. Following filters are available:

- prefilters to eliminate rough impurities;
- fine filters to eliminate micro-drops of liquid and powdered particles;
- the elimination of oil odours and vapours.

The first two filters are of a mechanic and coalescing type, while the third is an adsorption type.

OPTIONAL FOR FM FILTERS

DIFFERENTIAL GAUGE



Displays the exact saturation degree of the filter element.

DIFFERENTIAL PRESSURE INDICATOR



Two-tone visual indicator, regulated by the differential pressure, to visualize the clogging degree of the filtering element.

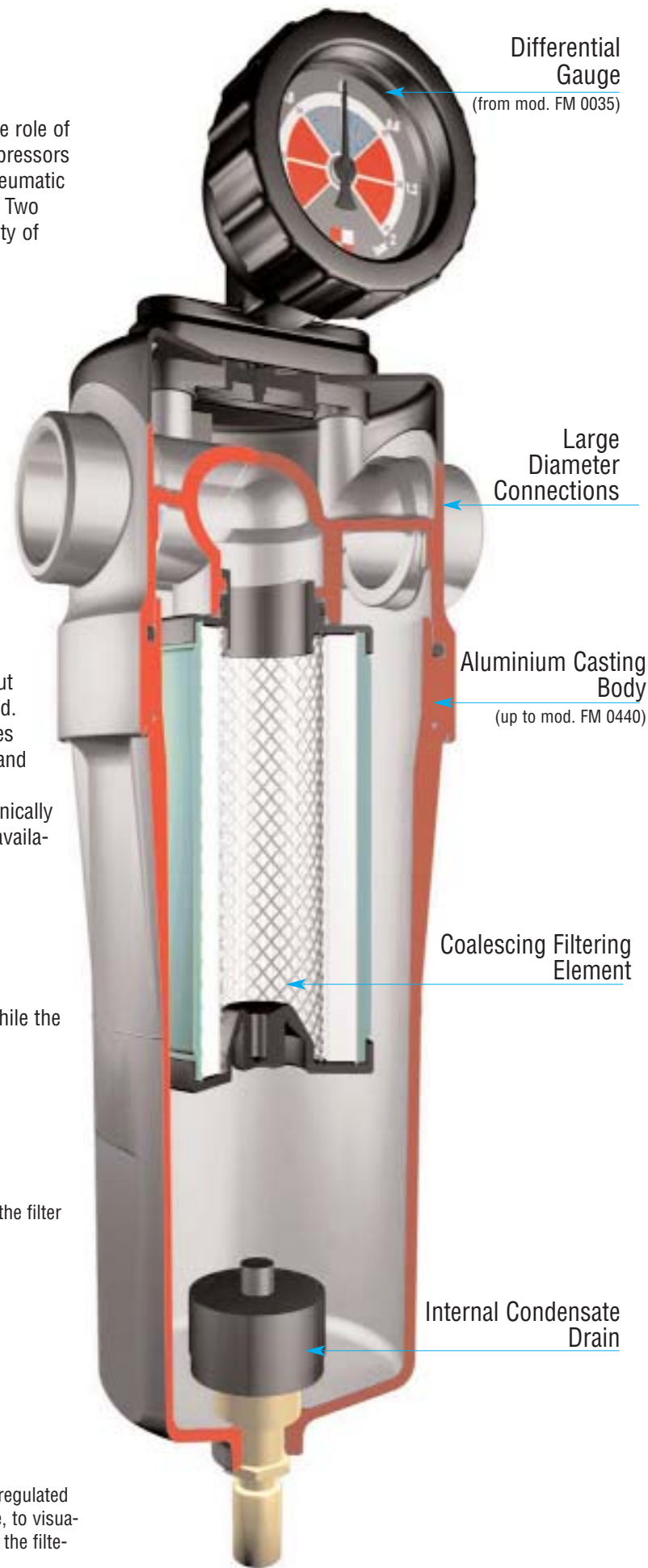

COMPRESSED AIR FILTRATION

GRADE C4 Dust filter

Dust retention filter to remove solid particles up to 25 micron. It is suitable as a prefilter in a plant where compressed air is produced by compressors not equipped with an effective filtering and oil removing system. Maximum working temperature: 100 °C.

GRADE C3 Prefilter

Prefilter removing solid particles larger than 5 micron and liquid particles up to 5 mg/m³. It is suitable as initial protection for a compressed air system or a refrigerant dryer, for general application in pneumatic devices, as a prefilter for "C2" grade filters and as a post-filter for adsorption dryers. Maximum working temperature: 100 °C.

GRADE C2 Oil removing filter

This coalescing filter removes solid particles up to 1 micron and liquid particles up to 0,1 mg/m³. It is suitable to remove large oil quantities. Maximum working temperature 100 °C.

GRADO C1 Oil removing filter

Coalescing filter removing solid particles up to 0,1 micron and liquid particles up to 0,01 mg/m³. This filter is required for an effective retention of the oil residue, around 99,99%, and delivers technically oil free air. Maximum working temperature 100 °C.

GRADO CC Activated carbon filter

It is used to eliminate oil vapours and odours and for the final treatment of compressed air. The filtering element is made of activated carbon, with an external steel mesh. The adsorption principle removes vapours and residual odours of the oil retention process. A grade C1 filter should be always placed before it. Maximum working temperature 60 °C.

APPLICATIONS

FM/C4

In industrial applications where high air quality is not essential: as pre-filter for further filtration and placed after centrifugal separators and adsorption dryers. **It removes 99% of liquid and solid particles up to 25 micron.**

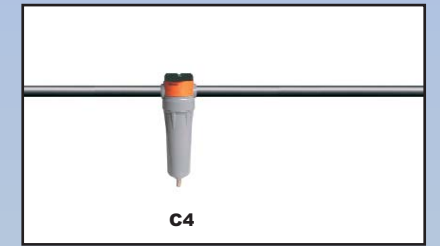

FM/C4 - FM/C3 - REFRIGERANT DRYER - FM/C2

Ideal for pneumatic plants, packaging and painting systems, compressed air motors and vacuum pumps. **Solid particles removal up to 1 micron. Maximum oil carry-over 0,1 mg/m³. Pressure dewpoint: +3°C.**

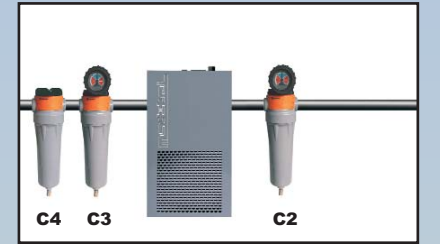

FM/C4- FM/C3 - REFRIGERANT DRYER - FM/C2 - FM/C1

Suitable for pneumatic transportation, pneumatic tools operation, pneumatic control, instrumentation, packaging and painting systems. **It removes solid particles up to 0,1 micron. Maximum oil carry-over 0,01 mg/m³. Pressure dewpoint: +3°C.**

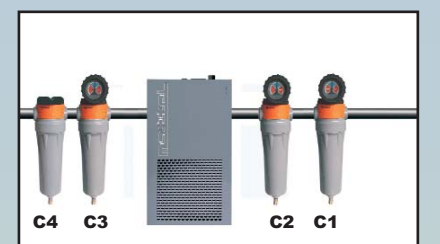

FM/C4 - FM/C3 - REFRIGERANT DRYER- FM/C2 - FM/C1 - FM/CC

Ideal for oil odour and vapour free compressed air. Suitable for all the above applications as well as breweries, food and beverage plants, hospital applications, galvanization, electronic instruments, packaging, bottling, decompression chambers, pharmaceutical and refrigeration industries, etc. **It removes solid particles up to 0,01 micron. Maximum oil carry-over 0,008 mg/m³. Pressure dewpoint: +3°C.**

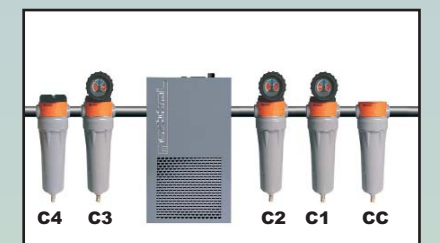

FM/C2 - FM/C1 - ADSORPTION DRYER- FM/C3

Suitable for all the above applications with the addition of pneumatic controls, painting, pneumatic transportation, packaging, instrumentation or whenever a pressure dew point of -40°C is needed. **It removes solid particles up to 0,01 micron. Maximum oil carry-over 0,01 mg/m³. Pressure dewpoint: -40°C.**

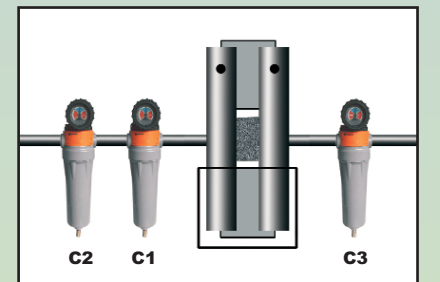

FM/C2 - FM/C1 - ADSORPTION DRYER - FM/C3 - FM/CC

Dry, odourless and technically oil free compressed air. Suitable in all oil free processes such as food and beverage industry, hospital applications, pharmaceutical processes, galvanization and laboratories. **Maximum oil carry-over 0,008 mg/m³. Pressure dew point: -40°C.**

